

KVPX Series

Application Specification #S50807

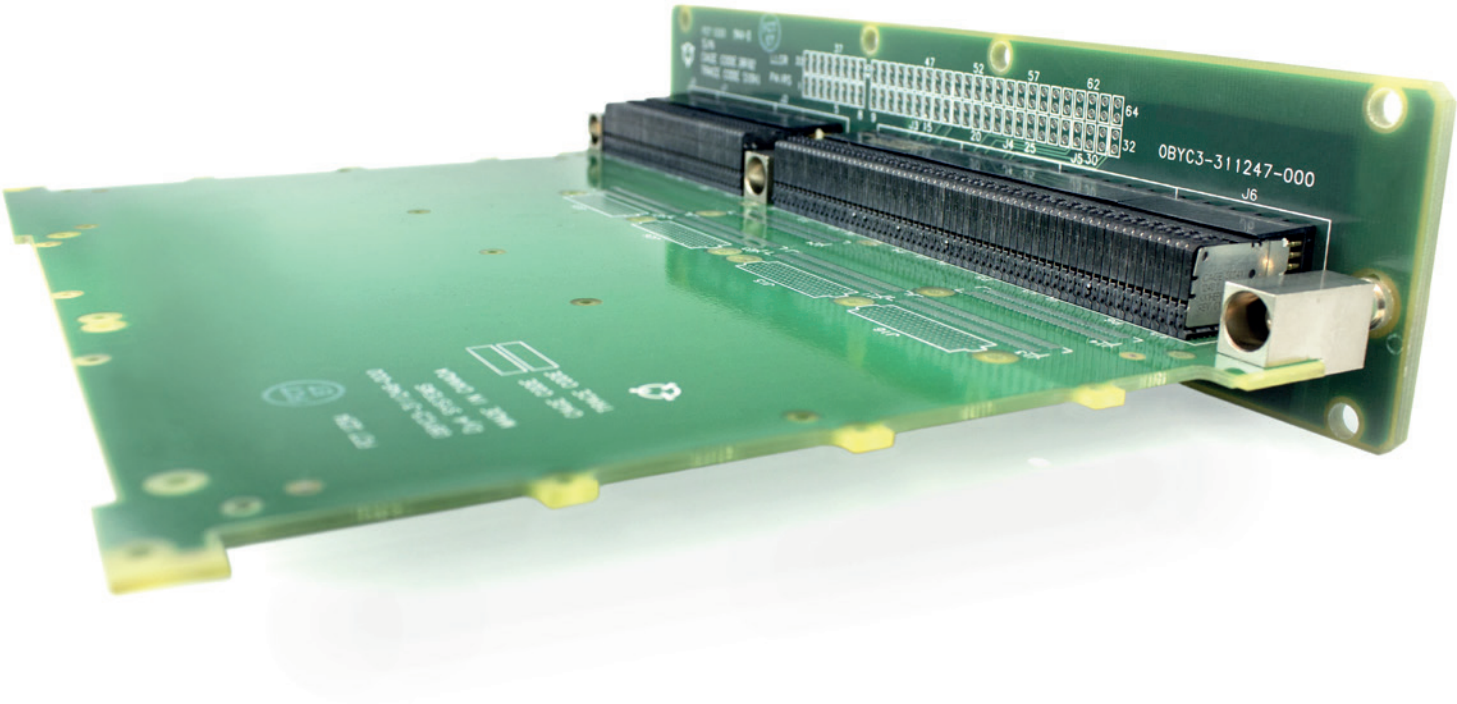

Content

1. Product information	3
1.1. Daughtercard modules	3
1.2. Backplane modules	4
2. Installation tooling	5
2.1. Individual module tools	5
2.2. Tools	6
3. Installation	7
3.1. Daughtercard module	7
3.2. Backplane module	10
4. Printed circuit board	12
4.1. Daughtercard	12
4.2. Backplane	16
5. Module details	18
6. Guide hardware	19
6.1. Guide socket installation	20
6.2. Guide pin installation	20
6.3. Guide hardware mounting detail	21
7. Mating sequence	22
7.1. Maximum allowable separation	23

1. Product information

1.1. Daughtercard modules

Part Number	Description	End Shield (Y/N)	Mating Backplane Module
KX1FCD02C1TBH	Full center differential module	N	KX2FCU01C1TAH
KX1FED02C1TBH	Full end differential module	Y	
KX1FCS02C1TBH	Full center single ended module	N	
KX1FES02C1TBH	Full end single ended module	Y	
KX1FCP02C1TBH	Full center full power module	N	
KX1FEP02C1TBH	Full end full power module	Y	
KX1FCH02C1TBH	Full full center hybrid module	N	
KX1HCP02C1TBH	Half center utility module	N	KX2HCU01C1TAH
KX1HEP02C1TBH	Half end utility module	Y	

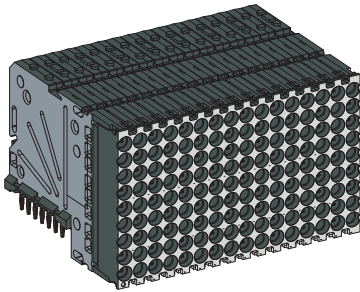

KX1FCD02C1TBH

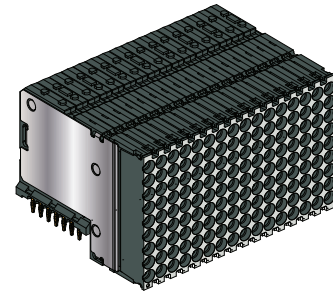

KX1FED02C1TBH

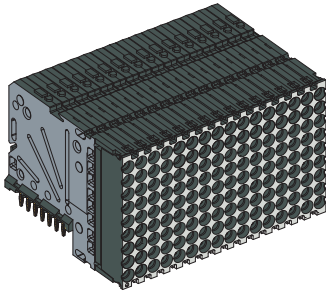

KX1FCS02C1TBH

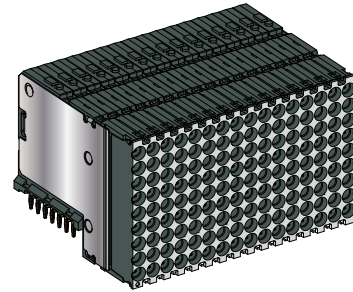

KX1FES02C1TBH

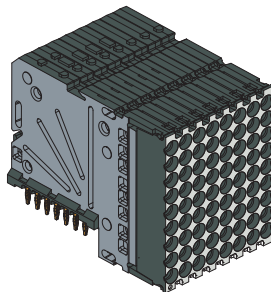

KX1HCP02C1TBH

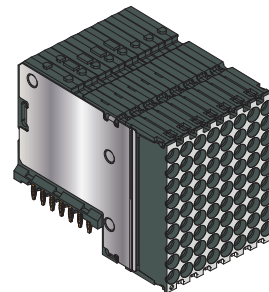

KX1HEP02C1TBH

1.2. Backplane modules

Part Number	Description	Equivalent Part Numbers
KX2FCU01C1TAH	Full 144-pin female connector	N/A
KX2HCU01C1TAH	Half 72-pin female connector	KX2HEP01C1TAH

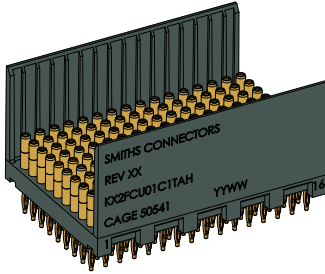

KX2FCU01C1TAH

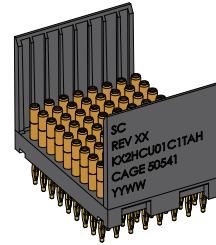

KX2HCU01C1TAH

2. Installation tooling

2.1. Individual module tools

Part Number	Description	Compatible Modules
T3194-02	Daughtercard module installation tool, 144-pin*	KX1FCD02C1TBH
		KX1FED02C1TBH
		KX1FCS02C1TBH
		KX1FES02C1TBH
		KX1FCP02C1THB
		KX1FCH02C1THB
T3194-01	Daughtercard module installation tool, 72-pin*	KX1HCP02C1TBH
		KX1HEP02C1TBH
T3055	Backplane module installation tool, 144-socket**	KX2FCU01C1TAH
T3079	Backplane module installation tool, 72-socket**	KX2HCU01C1TAH

* Only to be used with single module applications.

** For applications with adjacent module it is necessary to ensure that the first module is installed with the plastic "step" on the inboard side of the connector. All adjacent modules are to be installed in order following the same rule. See below:

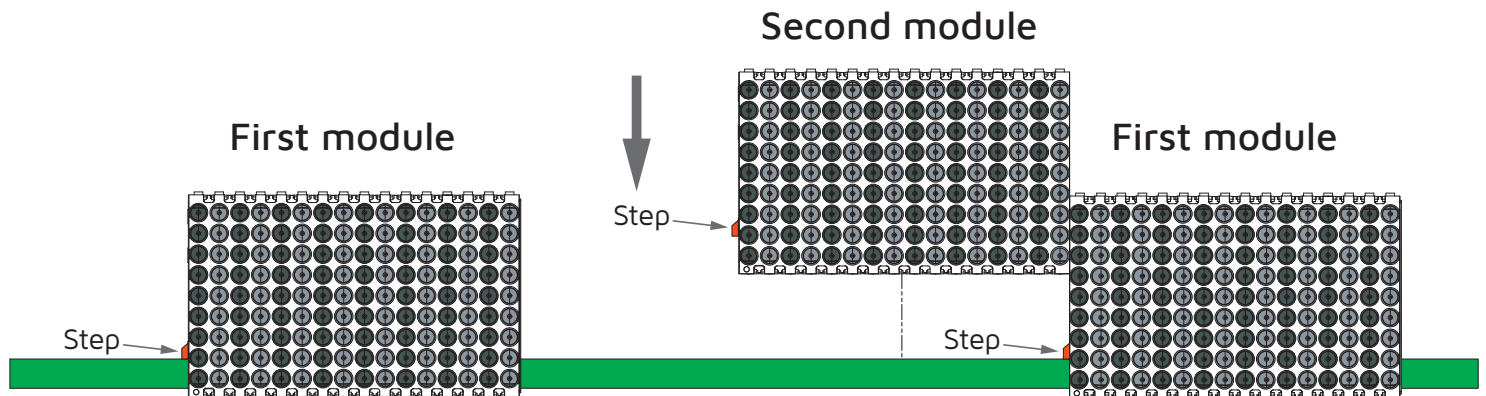

3U/6U tools

Part Number	Description
T3099	3U installation tool, backplane modules
T3099 & T3100	6U installation tools, backplane modules
T3197	3U installation tool, daughtercard module
T3197 & T3196	6U installation tools, daughtercard module

2.2. Tools

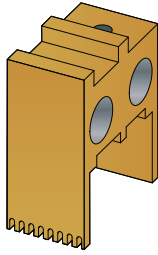

T3194-01

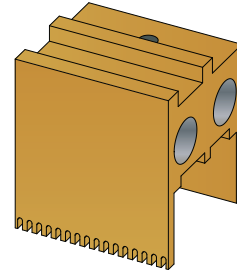

T3194-02

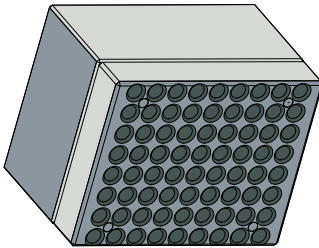

T3079

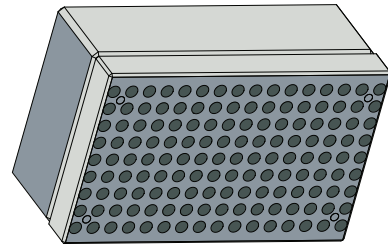

T3055

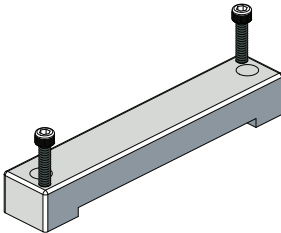

T3099

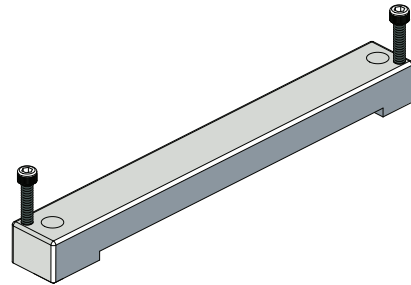

T3100

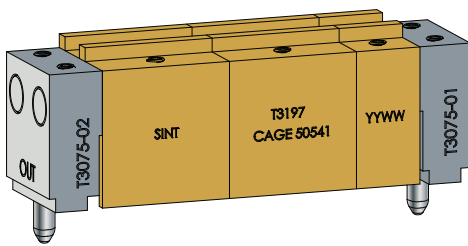

T3197

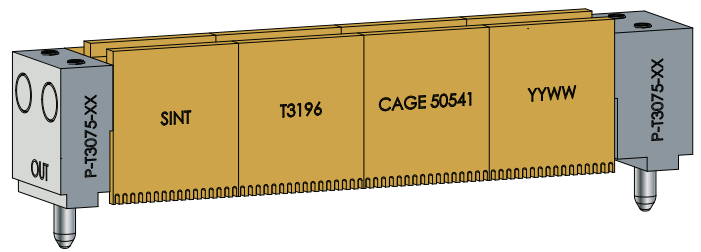

T3196

3. Installation

3.1. Daughtercard module

Caution: please wear safety glasses

3.1.1 Fit connector module to tool. Ensure that location posts fit into tool comb as shown.

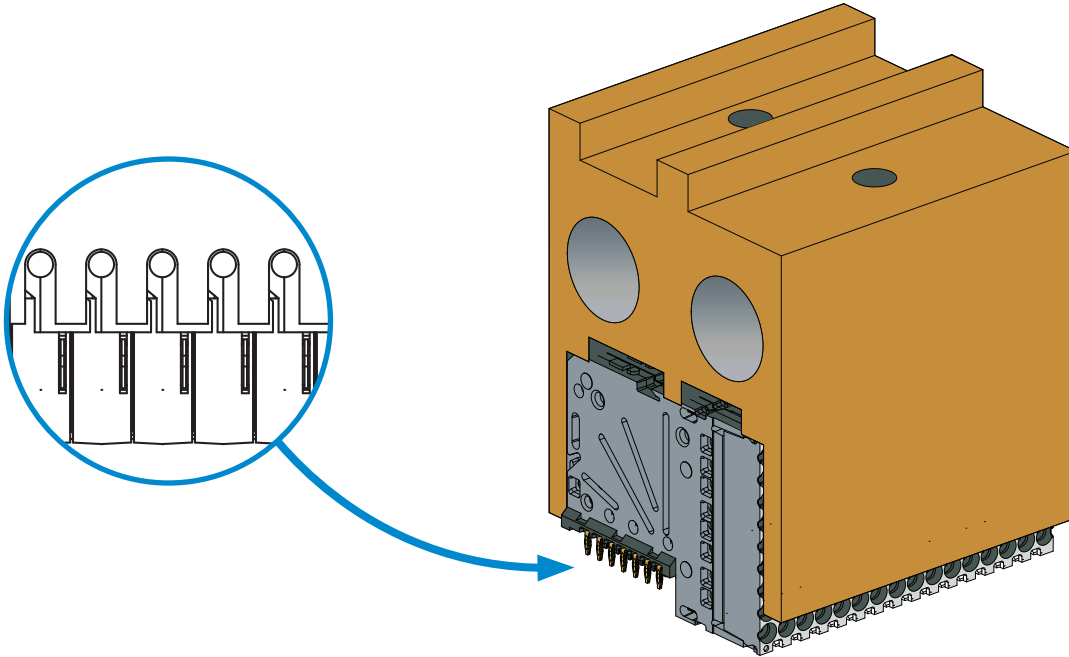

3.1.2 Align compliant terminals with printed circuit board.

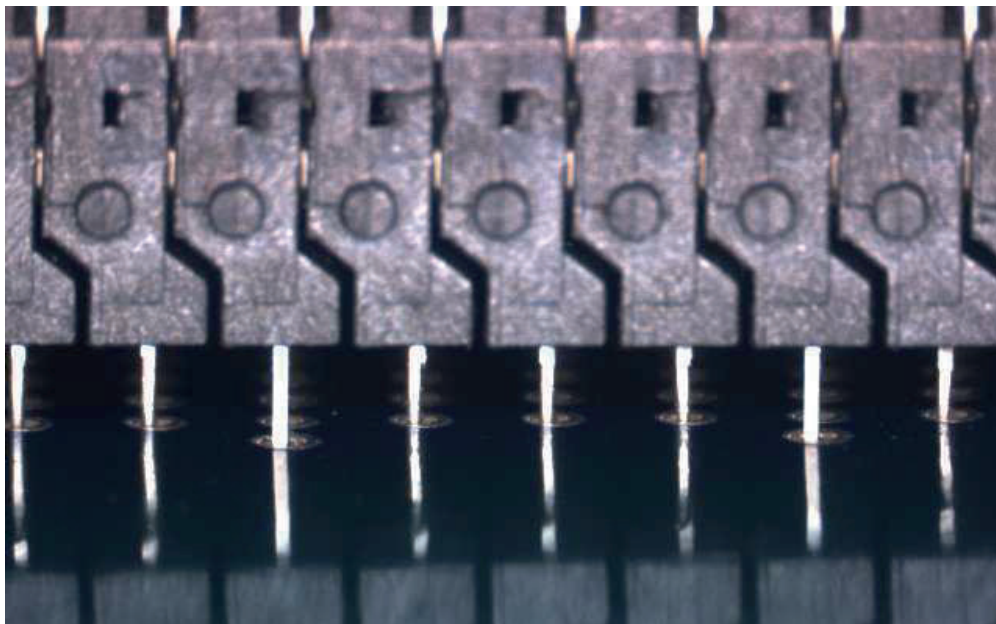

Note Compliant terminals must be aligned with plated thru-holes.

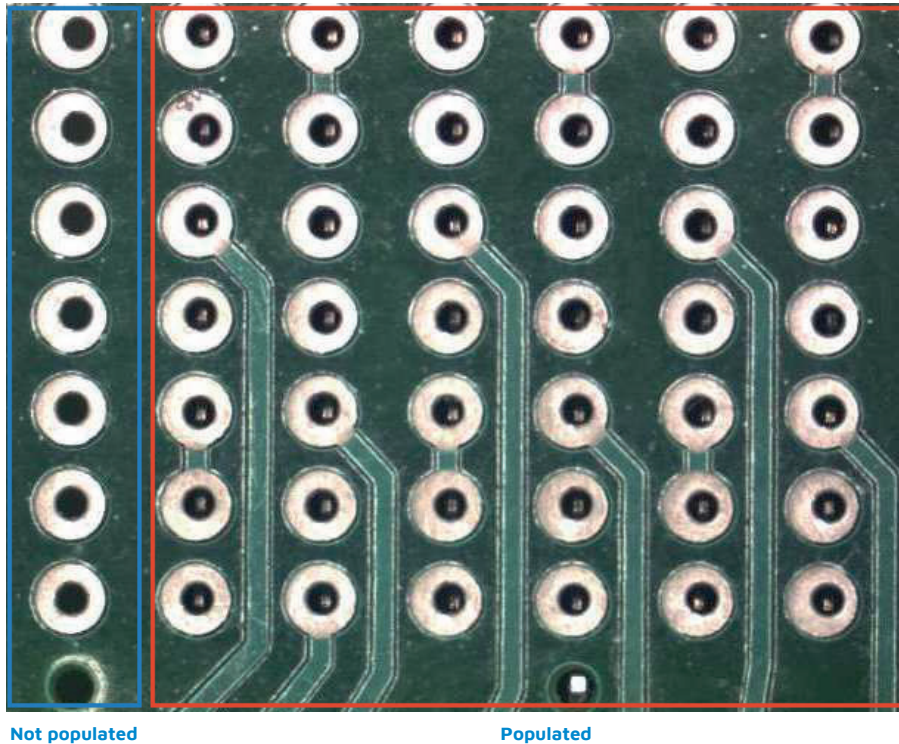

Not populated

Populated

3.1.3 Application fixture is intended to provide proper alignment of tools and connectors during pressing operation. Mount PCB/connector/tool on application fixture. If pressing in a 3U/6U assembly, align dowel pins with holes on PCB and fixture.

3.1.4 Apply steady force to center of tool. Make certain that there is no gap between the PCB and connector. Approximate force per full 16 wafer module is:

250 lbf (SnPb via)

350 lbf (ENIG via)

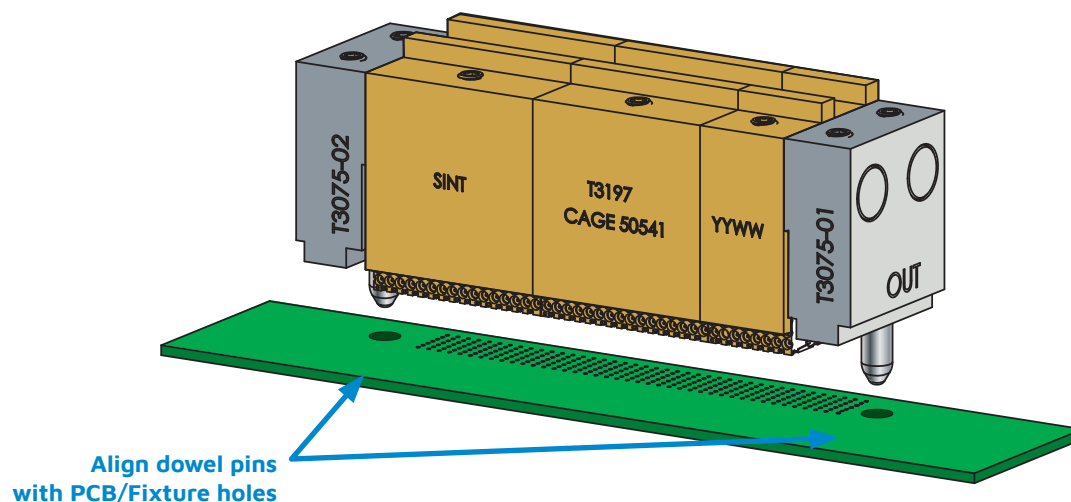

Align dowel pins
with PCB/Fixture holes

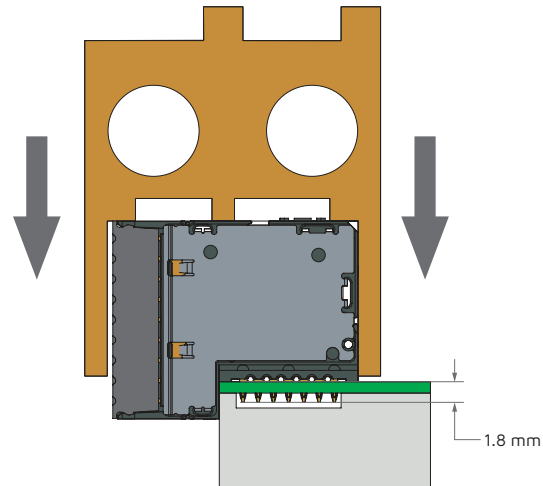

- 3.1.5 When pressing into the PCB, the front edge of the connector must have clearance from the bottom fixture. If PCB thickness is less than 1.8 mm [0.071 in.], then the bottom fixture must have clearance for the compliant pins.

3.2. Backplane module

3.2.1 Fit connector module(s) to tool. Sockets will fit into the tool cavities.

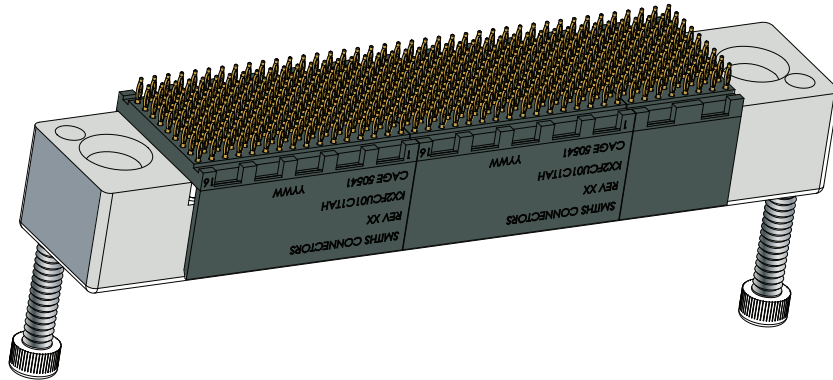

3.2.2 Align compliant terminals with PCB. Inspect PCB from reverse side and ensure that the compliant terminals are aligned with plated thru-holes. If pressing in a 3U/6U assembly, align assembly tool with guide pins on PCB.

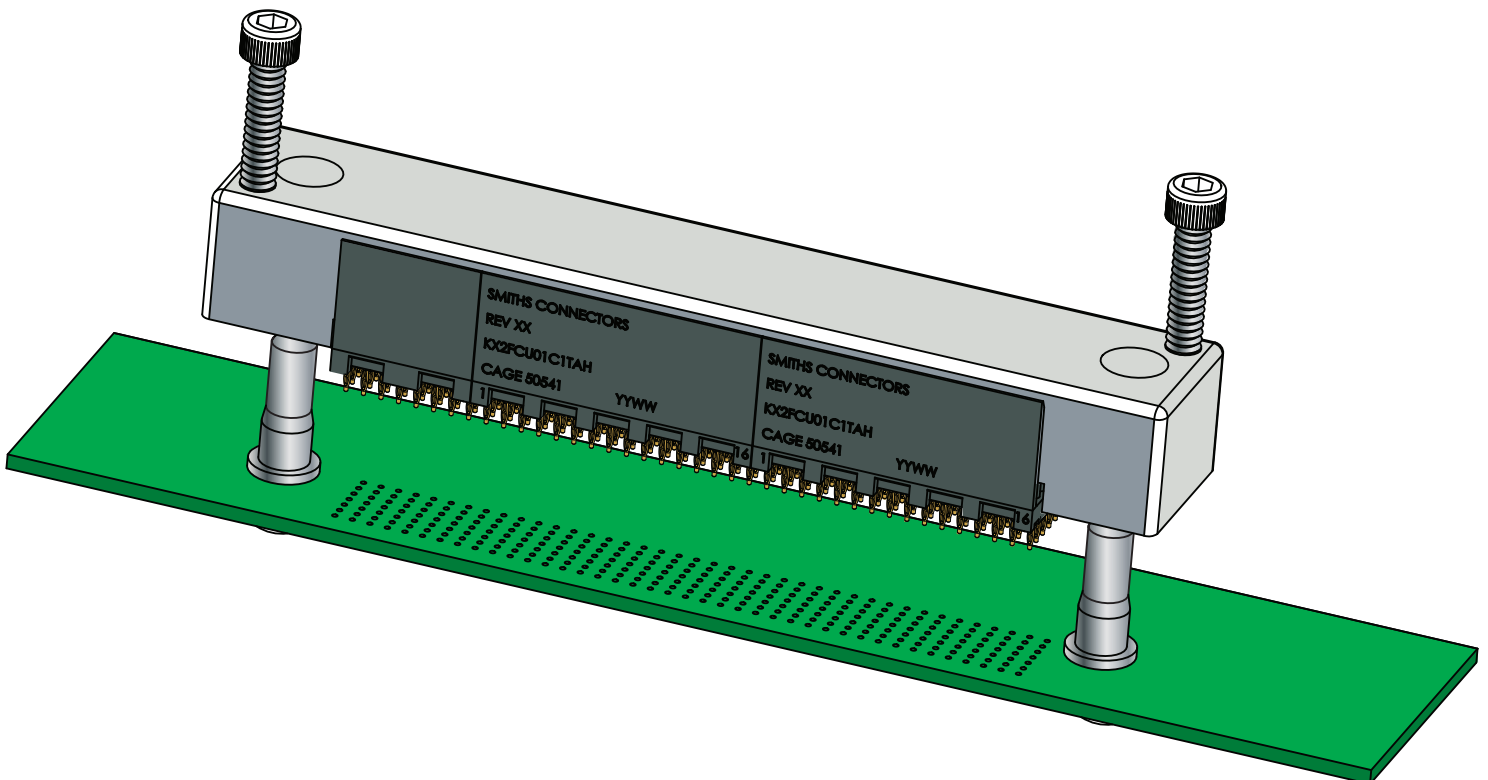

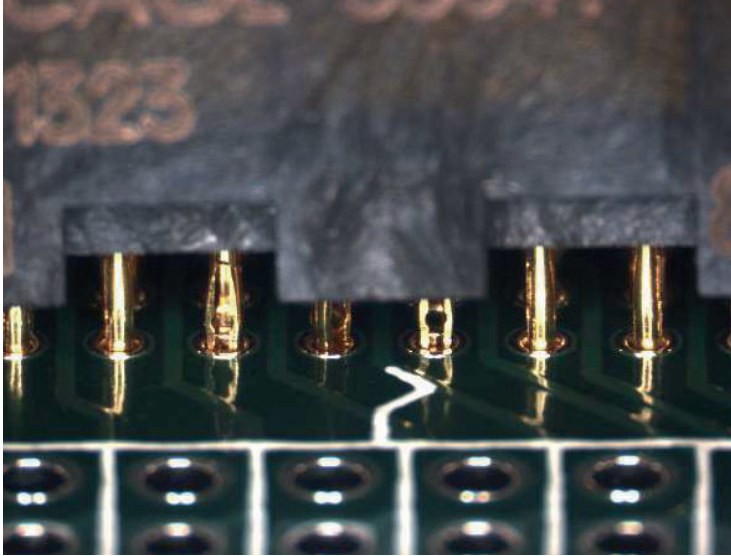

Compliant terminals must be aligned with plated thru-holes

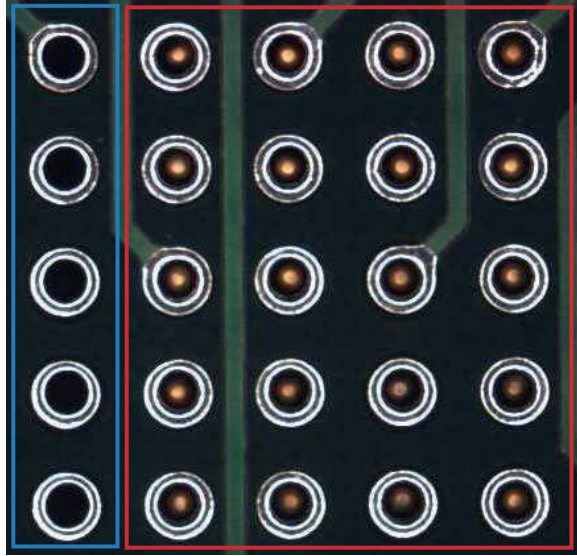

Not populated

Populated

3.2.3 Apply steady force to center of tool. Make certain that there is no gap between the PCB and connector. To remove the tool, evenly lift tool off of the connector.

Note If using the optional jackscrews, evenly turn both extraction screws clockwise to press tool off of connector.

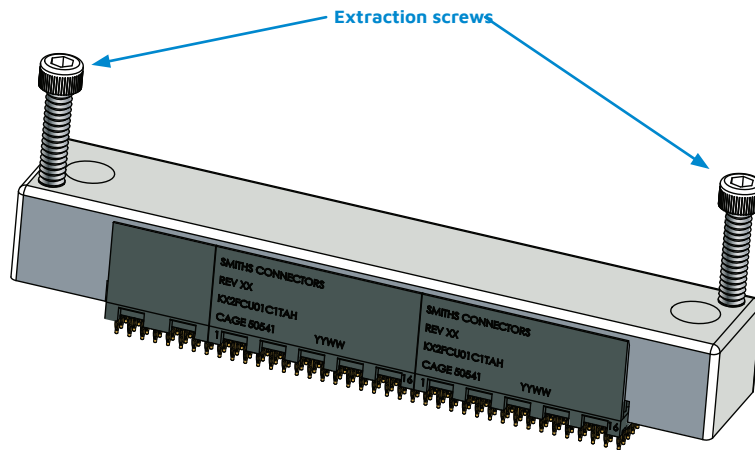

3.2.4 Approximate installation force per full 144 contact module:

75 lbf (SnPb via)

125 lbf (ENIG via)

4. Printed circuit board

4.1. Daughtercard

PC Board

- Minimum board thickness of 1.60 mm [0.063 in.].
- Maximum allowable bow of PCB shall be 0.03 mm [0.001 in.] over the length of each individual module.

Manufacturing tolerance for \varnothing 0.46 mm \pm 0.05 mm finished hole with SnPb plating

- Drilled hole = \varnothing 0.55 mm \pm 0.02 mm.
 - Cu Plating = 0.025 mm to 0.050 mm
 - SnPb plating = 0.0038 mm to 0.0124 mm

Manufacturing tolerance for \varnothing 0.46 mm \pm 0.05 mm finished hole with ENIG plating

- Drilled hole = \varnothing 0.55 mm \pm 0.02 mm.
 - Cu Plating = 0.025 mm to 0.050 mm
 - ENIG plating = 0.0001 mm to 0.0005 mm (Au) over 0.00127 mm to 0.0076 mm (Ni)

Manufacturing tolerance for \varnothing 0.46 mm \pm 0.05 mm finished hole with ENIG plating per IPC-4552:

- Drilled Hole = \varnothing 0.55 mm \pm 0.02 mm.
 - Cu Plating = 0.025 mm to 0.050 mm
 - ENIG Plating = 0.00005 mm to no max (Au) over 0.0030 mm to 0.0060 mm (Ni)

PCB mounting pattern

Differential module

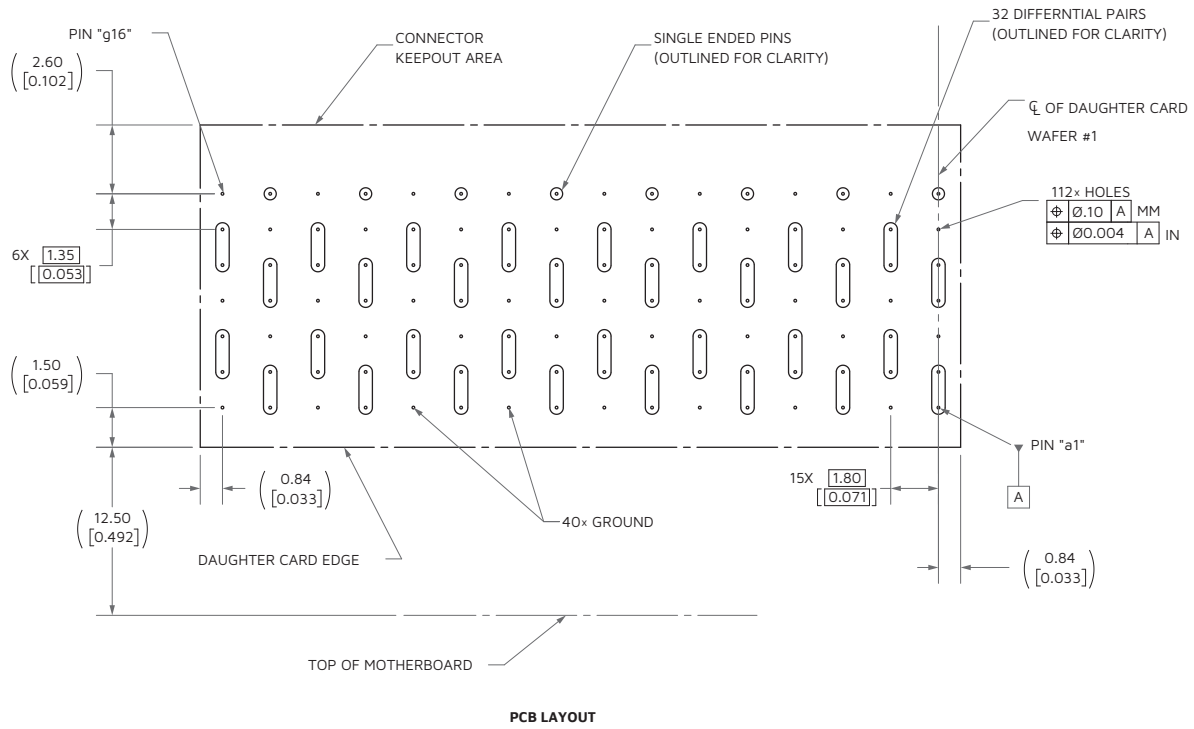

Single-ended module

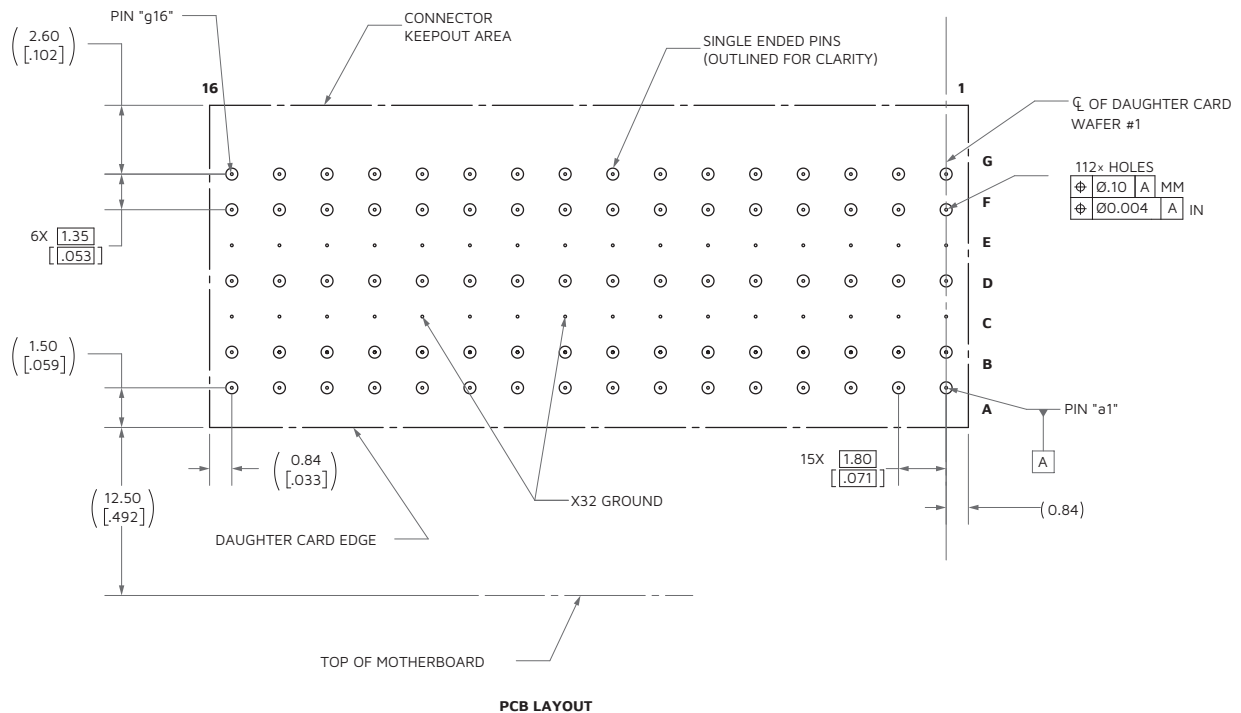

Note Dimensions are in mm [in.].

Utility module

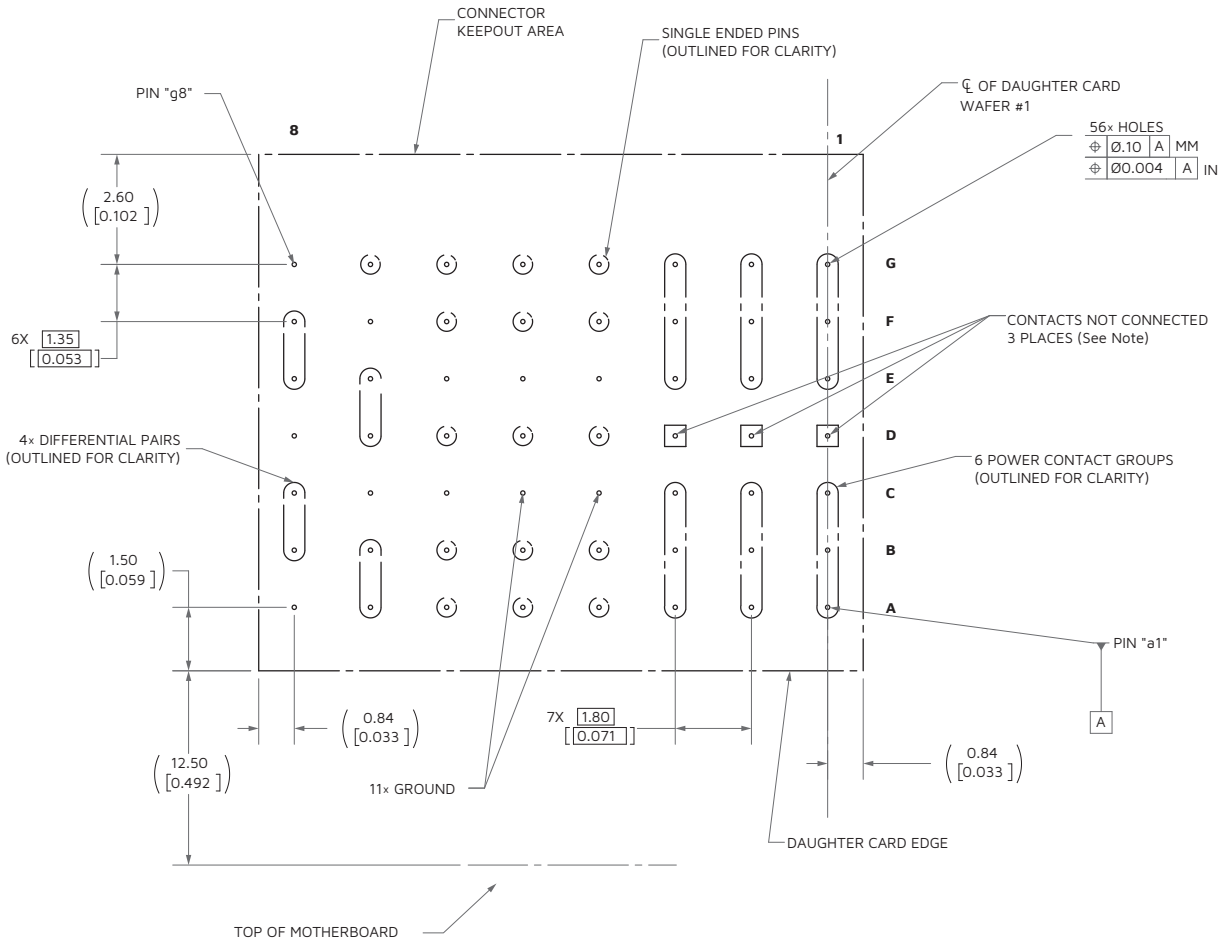

Note There is no terminal in these locations, therefore the plated through hole on the PCB can be eliminated. If the plated through hole will be present, it is suggested to those using KVPX in space applications to properly ground these plated through holes within the PCB when installing a utility module. Failure to do so will result in ungrounded contacts within the power wafer portion of the connector.

Note Dimensions are in mm [in.].

Half module

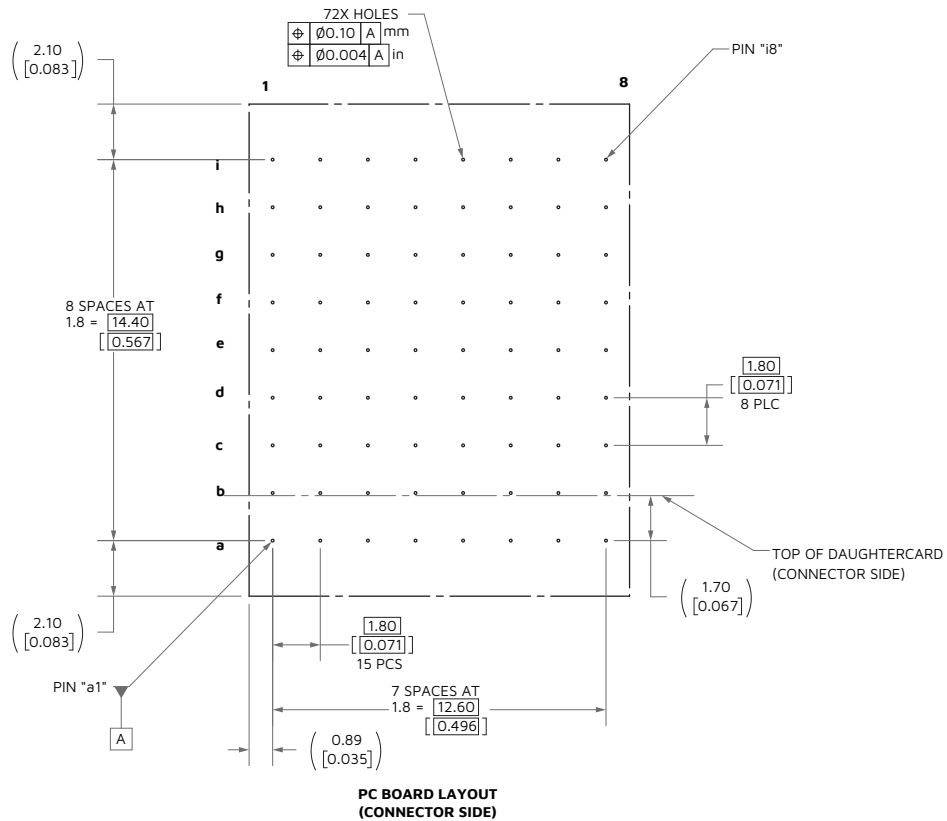

Note It is suggested to those using KVPX in space applications to properly ground these plated through holes within the backplane, when installing a utility module. Failure to do so will result in ungrounded contacts within the power wafer portion of the connector.

6U backplane layout

See VITA 63.0 Appendix B for all backplane printed circuit board fabrication drawings

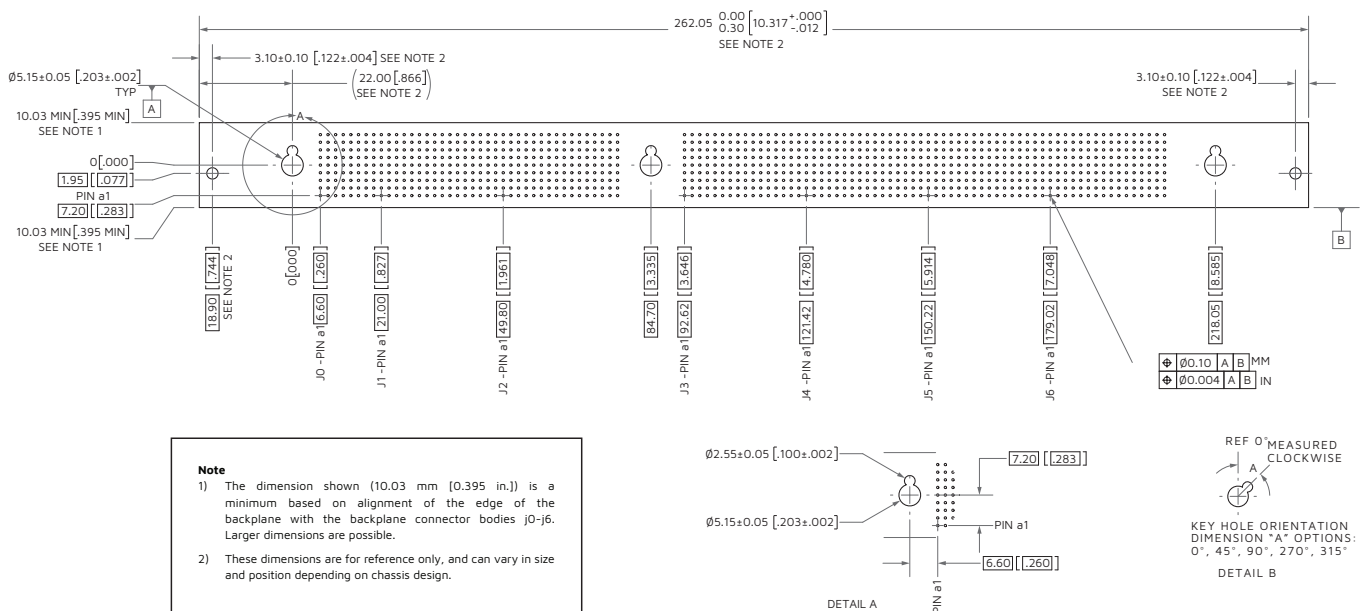

Note Dimensions are in mm [in.].

5. Module details

Single ended

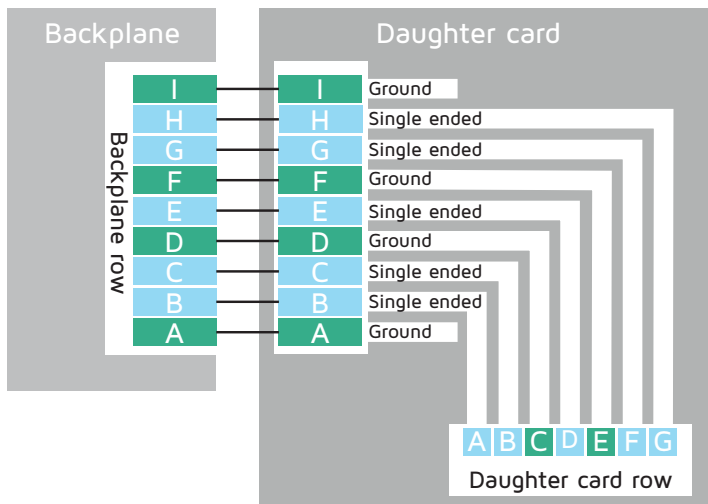
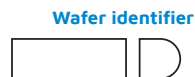

Single-ended wafer to backplane pin mappings

Odd wafer

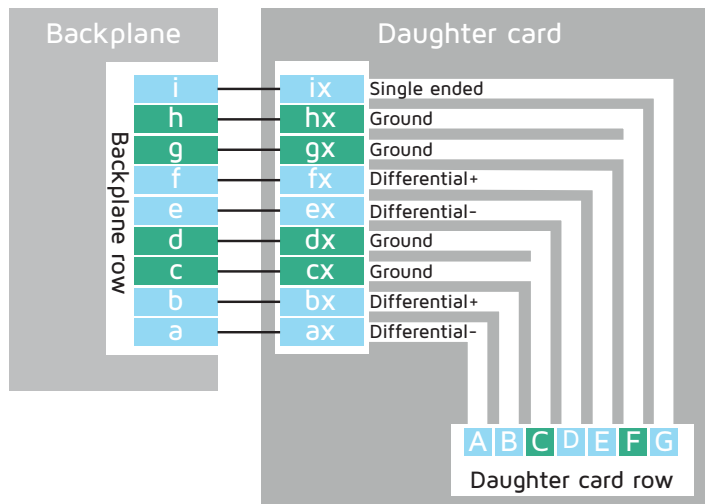

Odd differential wafer to backplane pin mapping

Even wafer

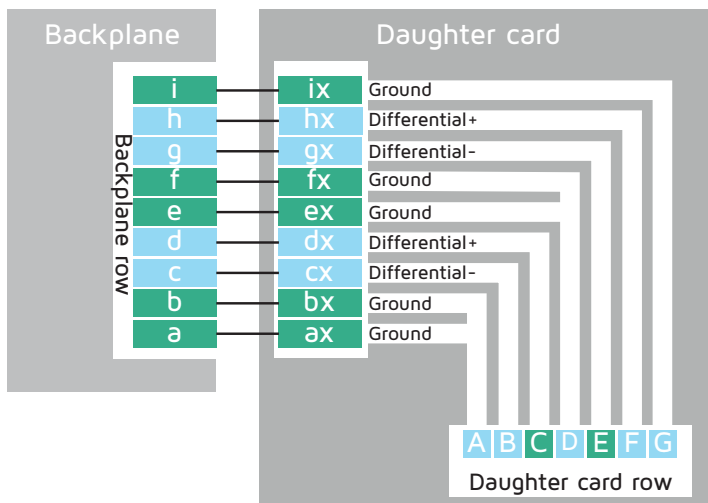
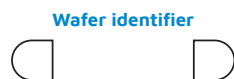

Even differential wafer to backplane pin mappings

Power

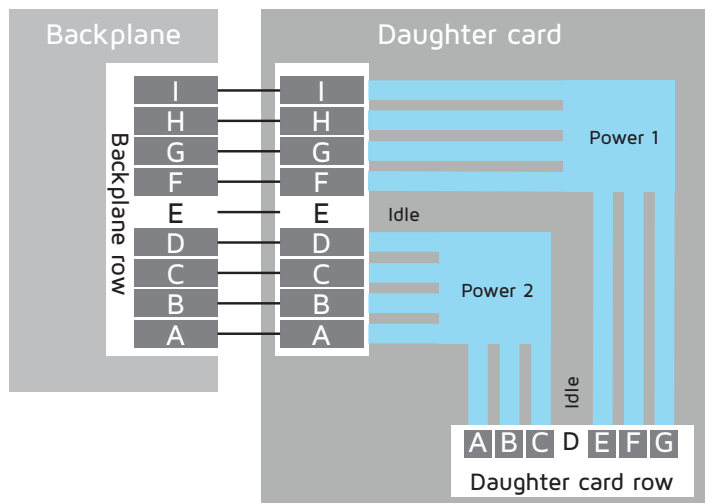





Power wafer to backplane pin mapping

Note: No compliant pin on daughter card row D.

6. Guide hardware

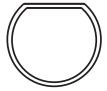
Pin Part Number	Socket Part Number	Description
YGP064-001P	YGS064-004ANH	Left
	YGS064-005ANH	Center (6U Only)
	YGS064-006ANH	Right

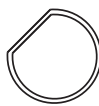
Note For keying options, add a "-" and the number below for keying angle at the end of the part numbers listed above.

Keying angle	No keying -Omit		3	0°		
	1	90°		4	315°	
	2	45°		5	270°	

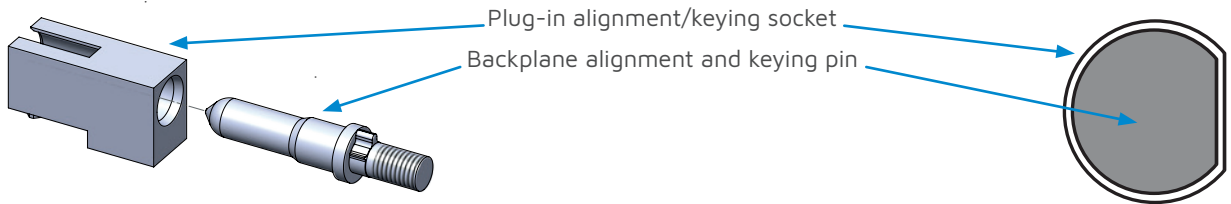

Note Mounting hardware is included with guide hardware.

6.1. Guide socket installation

6.1.1 Press guide socket into PCB. Make certain there is no gap between PCB and guide socket. Install guide sockets in the arrangement indicated below. (part number provided for reference).

3U socket configuration

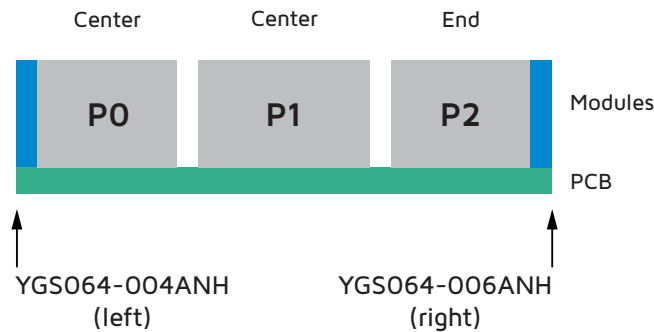

Note Perspective view is looking at the backplane

6U socket configuration

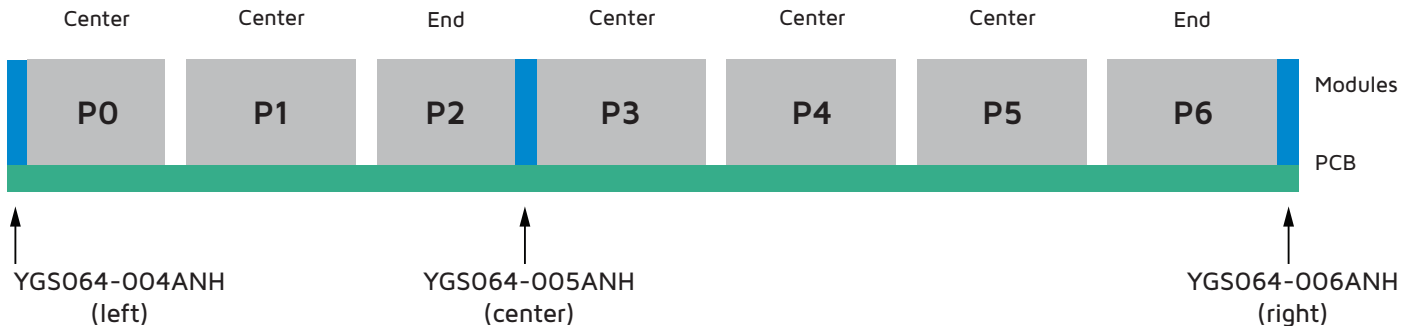

Note Perspective view is looking at the backplane

6.1.2 Apply thread locker to screw threads (optional).

6.1.3 Tighten M3×3.5 mm cap screw with a 1.5 mm Allen wrench to a maximum of 25 in.-oz.

6.2. Guide pin installation

6.2.1 Press guide pin into PCB. Make certain there is no gap between PCB and guide pin.

6.2.2 Apply thread locker to threads of hex nut.

6.2.3 Tighten M5×8 mm hex nut to a maximum of 55 in.-oz.

6.3. Guide hardware mounting detail

6.3.1 Pin (backplane)

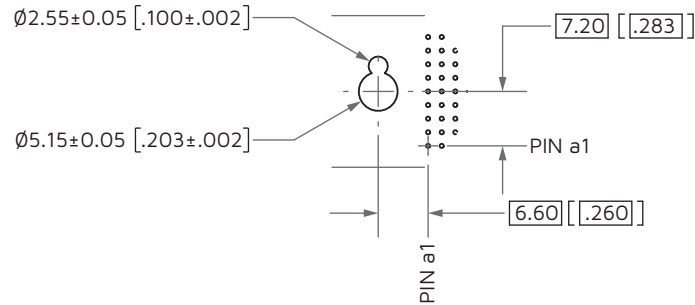

6.3.2 Socket (plug-in)

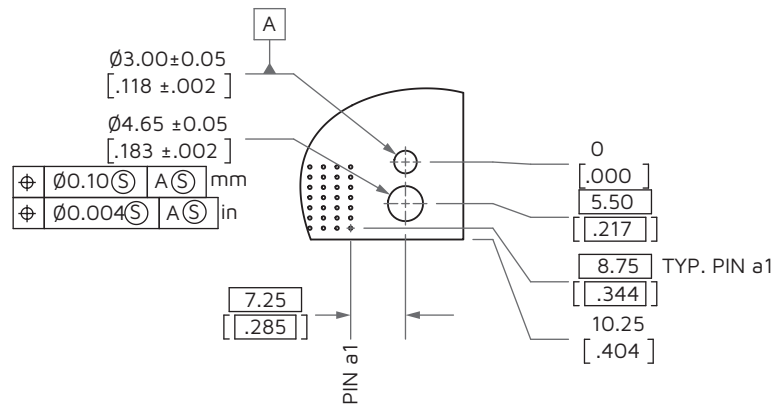

Note Dimensions are in mm [in.].

7. Mating sequence

Mating sequence 1

(Guide pin engages guide socket)

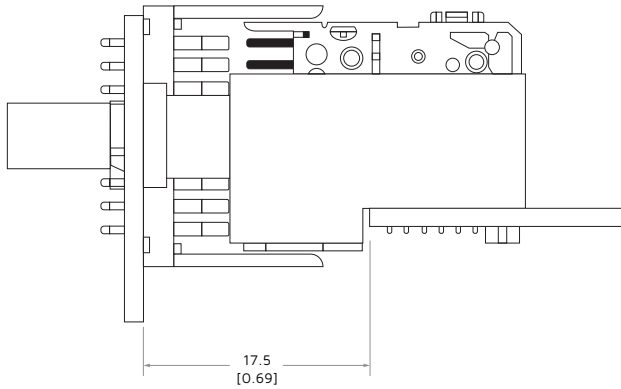

Mating sequence 2

(ESD contacts engage)

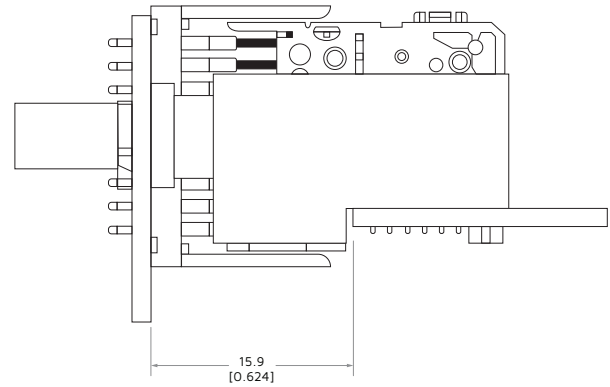

Mating sequence 3

(Ground contacts engage)

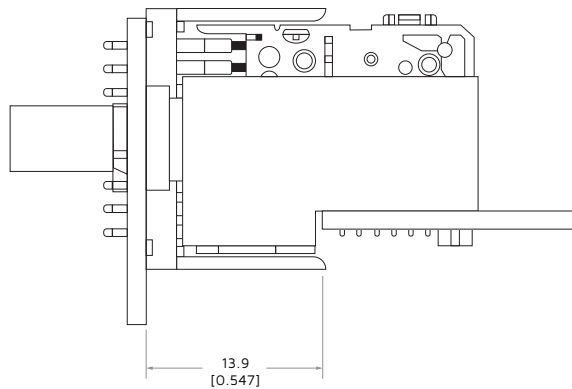

Mating sequence 4

(Signal contacts fully engaged / fully mated)

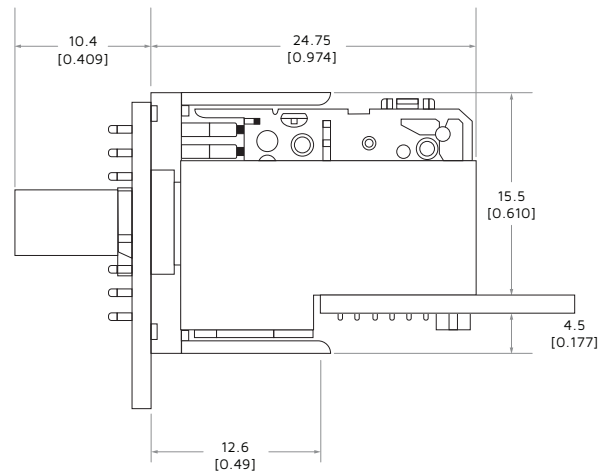

Note Dimensions are in mm [in.].

7.1. Maximum allowable separation

1.0 mm maximum allowable gap [.04 in.]

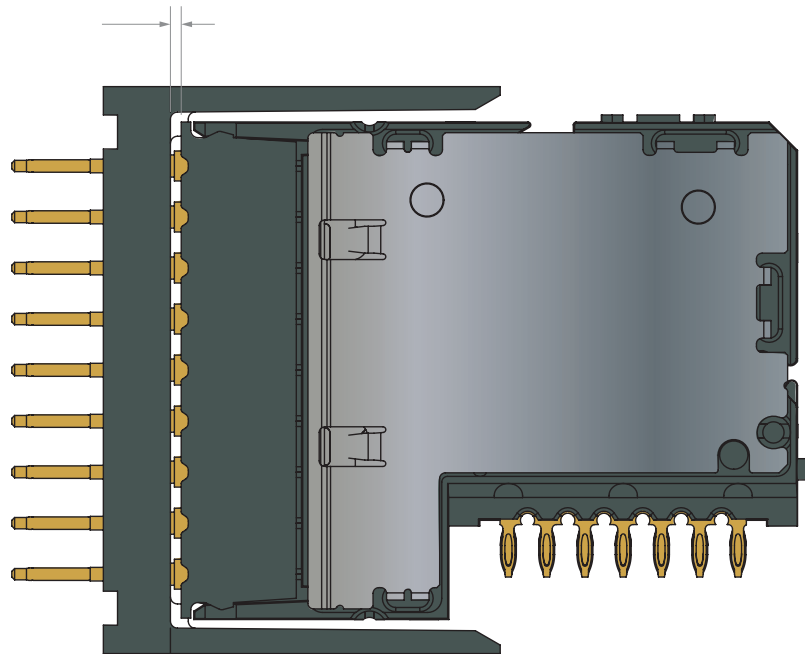

Disclaimer

All of the information included in this catalogue is believed to be accurate at the time of printing. It is recommended, however, that users should independently evaluate the suitability of each product for their intended application and be sure that each product is properly installed, used and maintained to achieve desired results.

Smiths Interconnect makes no warranties as to the accuracy or completeness of the information, and disclaims any liability regarding its use.

Smiths Interconnect reserves the right to modify design and specifications, in order to improve quality, keep pace with technological development or meet specific production requirements.

No reproduction or use without express permission of editorial and pictorial content, in any manner.

The revision history is tracked internally. Please contact Connectors Sales Support for information on past revisions of this document.



KENSINGTON

ELECTRONICS inc.

Not just products - Solutions!

INTERNATIONAL,
ALASKA & HAWAII

Please contact one
of the ISRs.

Courtney Darrah

Inside Sales Representative
cdarrah@keiconn.com
512-339-3324

Erin Gagne

Inside Sales Representative
egagne@keiconn.com
512-339-3331

Kevin Kientopf

Inside Sales Representative
kkientopf@keiconn.com
512-339-3315

Gabby Bozeman

Inside Sales Representative
gbozeman@keiconn.com
512-339-3325

John Davis

Inside Sales Representative
jdavis@keiconn.com
512-339-3311

North American Sales Support Coverage



Erin Gagne

Inside Sales Representative
egagne@keiconn.com
512-339-3331

Courtney Darrah

Inside Sales Representative
cdarrah@keiconn.com
512-339-3324

John Davis

Inside Sales Representative
jdavis@keiconn.com
512-339-3311

Gabby Bozeman

Inside Sales Representative
gbozeman@keiconn.com
512-339-3325

Kevin Kientopf

Inside Sales Representative
kkientopf@keiconn.com
512-339-3315

Scott Kirchmeier

Regional Sales Manager
sales@keiconn.com
619-247-0736 (M)
512-339-3312 (O)